

Parts list COMBISTAR 2000-A

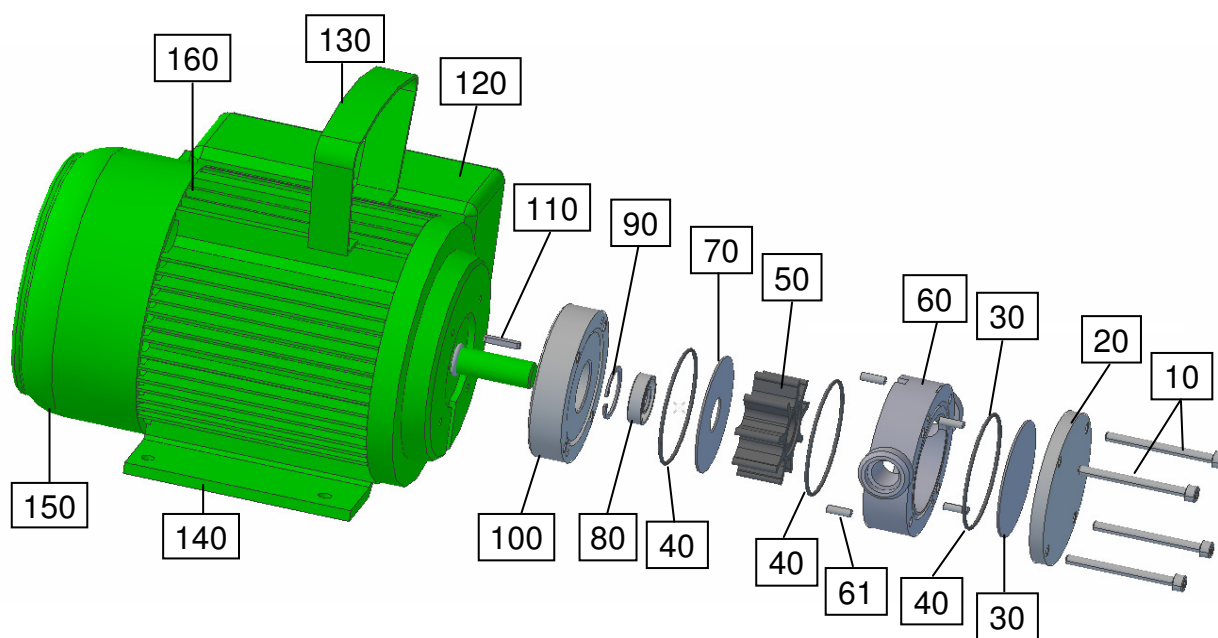

Parts list

Pos.:	Part / Designation	Code	Number
10	Hexagon head screw M5x55	70326	4
20	Front cover COMBISTAR	11012602	1
30	Wear plate without hole - stainless steel	11012009	1
40	O-ring 56-2 NBR	80003	3
40	O-ring 56-2 EPDM	80151	3
40	O-ring 56-2 VITON	80150	3
50	Impeller Perbunan Type A - polyamid bush	11012909	1
50	Impeller Perbunan Type A - stainless steel bush	11012908	1
50	Impeller Neoprene Type A - stainless steel bush	11012505	1
50	Impeller EPDM Type A - stainless steel bush	11012401	1
50	Impeller VITON Type A - stainless steel bush	11012801	1
50	Impeller VITON Type A - polyamid bush	11012810	1
50	Impeller Kunststoff Type A - polyamid bush	11012301	1
60	Housing COMBISTAR-A	11012605	1
61	Dowel 4x12 stainless steel	70268	4
70	Wear plate with punched hole - stainless steel	11012709	1
80	Rotary shaft seal 14x26x7 NBR	80537	1
80	Rotary shaft seal 14x26x7 EPDM	80540	1
80	Rotary shaft seal 14x26x7 VITON	80538	1
90	Locking ring I 26x1,2 steel	70284	1
100	Rear cover pump set	11012603	1
110	Feather key A3x3x16	70315	1
120	Switch box motor 230V	80628	1
120	Switch box motor 400V	80630	1
130	Handle for motor BG 71	14000202	1
140	Motor base	Fuss00071	2
150	Ventilator cowl for motor BG 71	80621	1



Parts list

Pos.:	Part / Designation	Code	Number
160	Motor 230V; 0,37KW; 1400 rpm, complete	80600	1
160	Motor 230V; 0,37KW; 2800 rpm, complete	80607	1
160	Motor 400V; 0,37KW; 1400 rpm, complete	80605	1
160	Motor 400V; 0,37KW; 2800 rpm, complete	80604	1

Dimensions COMBISTAR 2000-A

